

## Bay Fisher 23

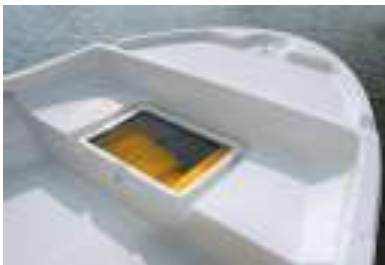

### Standard equipment

Bow compartment



Middle compartment



Livewell & scupper



Window shield & Rail



Console compartment



Tachometer



## Standard equipment



Steering



Remote control

## Stern compartment



Battery space and switch



Fuel tank compartment & 24L tank



Mooring eyes



Side graphic sticker

## Standard equipment

Bow compartment

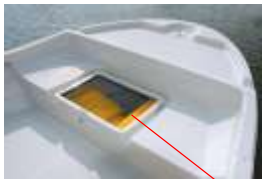

Middle compartment



Livewell & scupper



Window shield & Rail



Console compartment

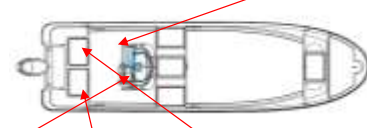
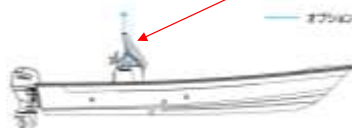
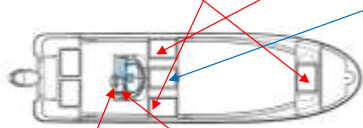

Steering



Remote control



Tachmeter

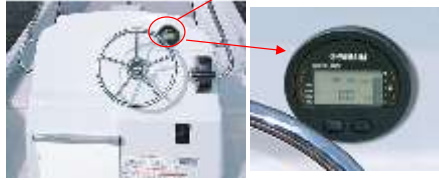

Battery space and switch



Stern compartment  
Fuel tank compartment & 24L tank



## Option

### Navigation light sets

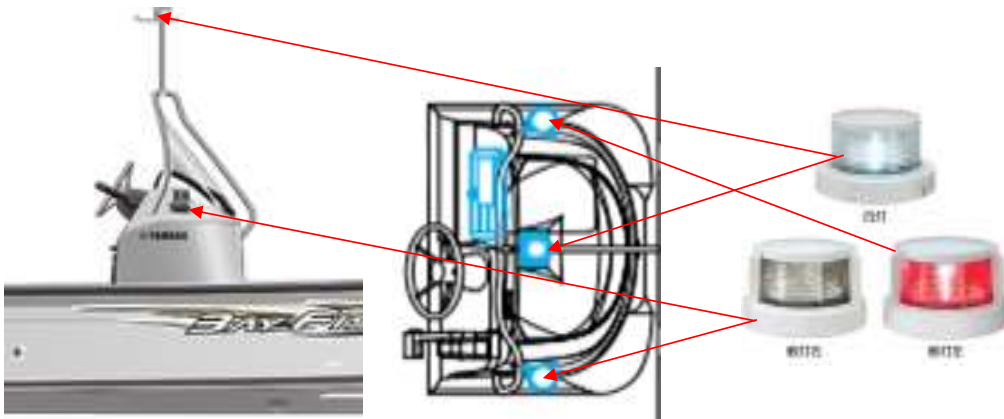

### Compass

